

DOUBLE "V" RAIL GATE PLAN

Double Gate Configuration - Tapered Top Rail

(4' & 8' FOOT WIDE 48" HIGH GATES) REAR EYE HINGES (Product Codes #8324) GATE HUNG BETWEEN POSTS

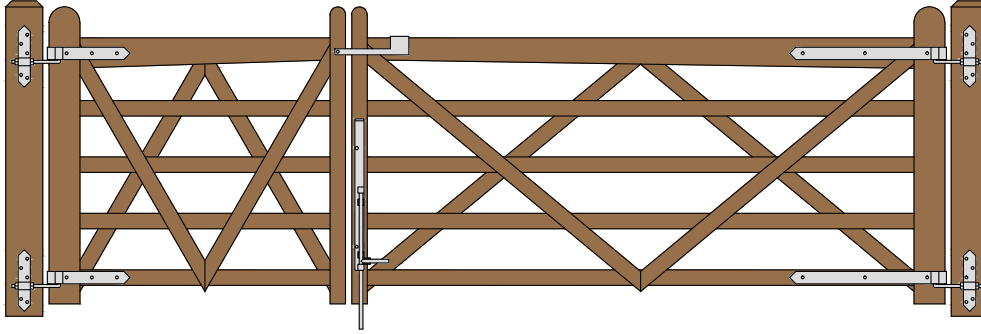

Distance between gate and hinge post	A
Width of Left Gate	B
Distance between gates	C
Width of Right Gate	D
Distance between gate and hinge post	E
Total distance between posts	F

Hardware Required								
	Galvanized Finish	Black Powder Coat over Galvanized Finish	Rear Eye Hinge Advantages					
Hinge Sets	1 of 8324-S122 and 1 of 8324-S242	1 of 8324-S12P and 1 of 8324-S24P	Opens 180 degrees Incredible amount of adjustment Easy operation & Very Strong Minimal distance between gate and post					
Fasteners included with double strap hinges - Mounting plate fasteners sold separately**	Two Sets Includes							
	two 12" double strap (8324-122 or 8324-12SP) & two 24" double strap(8324-242 or 8324-24SP) four mounting plate with 8" adjustable threaded pins(8256-342 or 8256-34P)							
Cane Bolt (Vertical)	1 or 2 of 5000-242*	1 or 2 of 5000-24SP*	Dimensions (feet and inches)					
Fasteners included with latches	Central Latch Options		A	B	C	D	E	F
Throw Over Gate Loop	4200-032	4200-03SP	1"	4'	1"	8'	1"	12' 3"
Slide Bolt Latch (Flush/ Jamb Mount)	5002-L122	5002-L12SP	1"	4'	1"	8'	1"	12' 3"
Lumber Required								
Posts	2 of 8' x 6" x6" (usually dressed out at 5.5" x 5.5")							
	Rails, Stiles (uprights) and Diagonals made from full 1" thick by 5.5" wide lumber (commonly stocked decking material or rough cut lumber)							
Top Rails (tapered)	5 of 8' x 1" x 5.5" (cut to 3 x 5.5" x 4' and 3 x 5.5" x 8')							
Rails	3 of 8' x 1" x 5.5" (cut to 4 x 2.5" x 4' and 4 x 2.5" x 8')							
Stiles	3 of 8' x 1" x 5.5" (4 x 5" x 4' for hinge sides and 4 x 2.5" x 4' for latch sides)							
Diagonals	1 of 8' x 1" x 5.5" (cut to 2.5" x 4') for the 4' gate and 1 of 10' x 1" x 5.5" (cut to 2.5" x 5') for the 8' gate							
Filler blocks for bottom hinge	use off cuts from other pieces for all filler blocks							
Fasteners Required								
	2 of FP-DoubleV Fastener pack for Double V Gate Build (One pack includes: 14 of 3.5" & 15 of 2.5" carriage bolts, washers and nuts & 40 of 1.75" wood screws)							
	**Mounting Plate Fasteners - 20 of 3/8" carriage bolts that are 1" longer than thickness of gate post (preferred) or 20 of 3/8" lag bolts (minimum of 4" long)							
	*One 24" Cane Bolt (5000-242 or 5000-24SP) is required for central stability. Two are needed if you require a means of keeping the gates open.							

SNUG COTTAGE HARDWARE

Download includes this materials list, component cutting and layout sheet, tips on installing gate posts, and detailed instructions.
 For a complete listing of our free gate plans and gate layouts visit hooverfence.com.

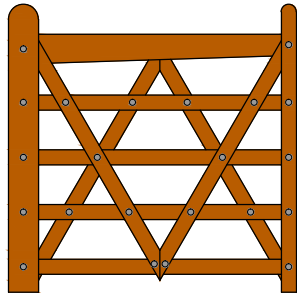

4' DOUBLE 'V' GATE

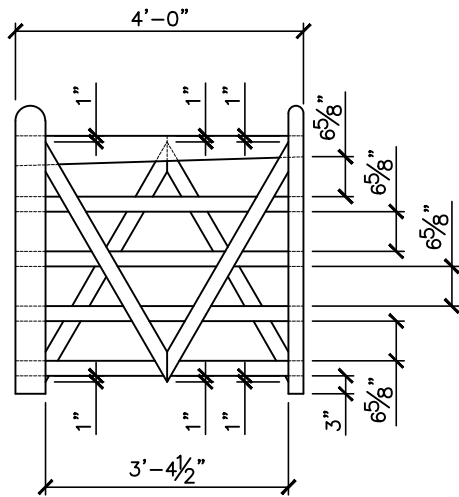

GATE DIMENSIONS

PROPERTY OF:
 SNUG COTTAGE
 HARDWARE LLC
 MARYSVILLE MI.
 48040

PRODUCT DESCRIPTION:
 4' DOUBLE 'V' GATE
 ALL DIMENSIONS ± 0.125 "

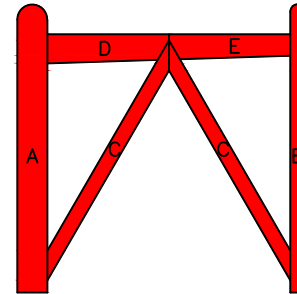

FIRST LAYER

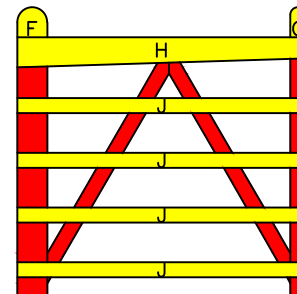

SECOND LAYER

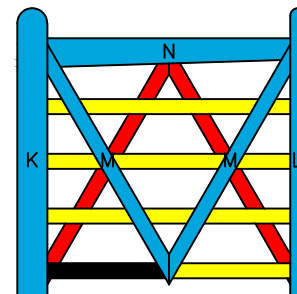

THIRD LAYER

BUILDING STEPS

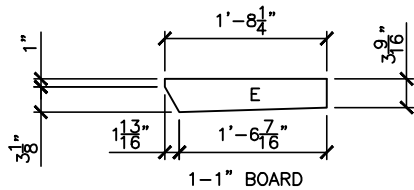
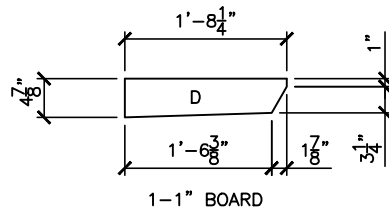
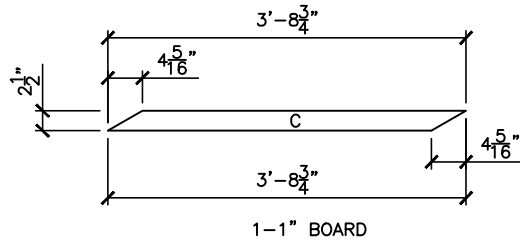
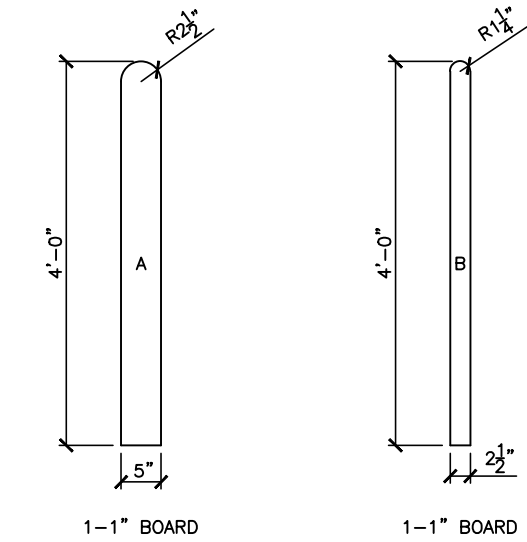

FIRST LAYER COMPONENTS

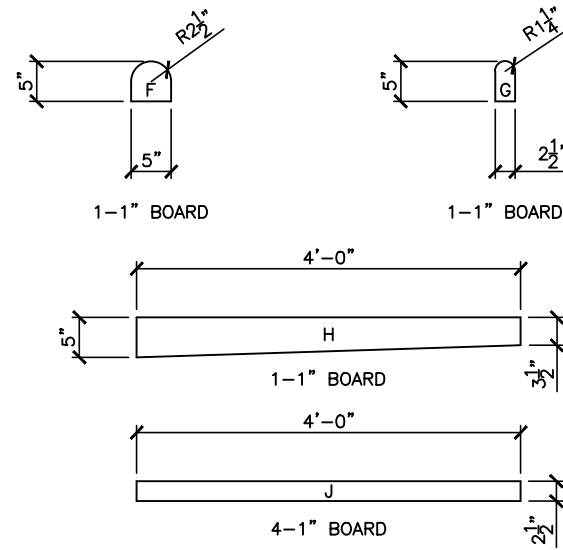

SECOND LAYER COMPONENTS

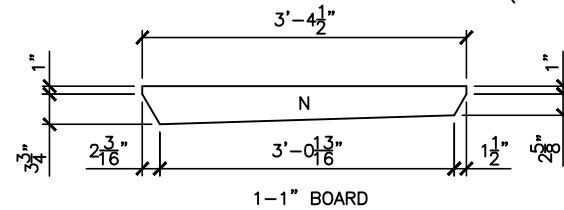
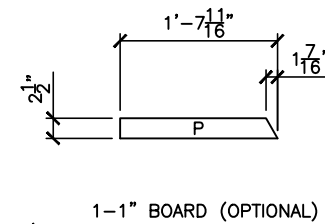
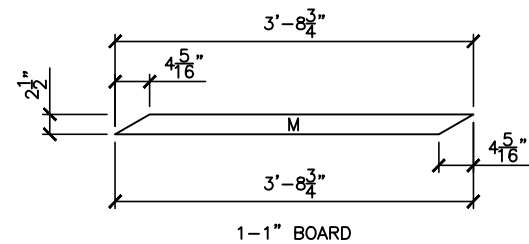
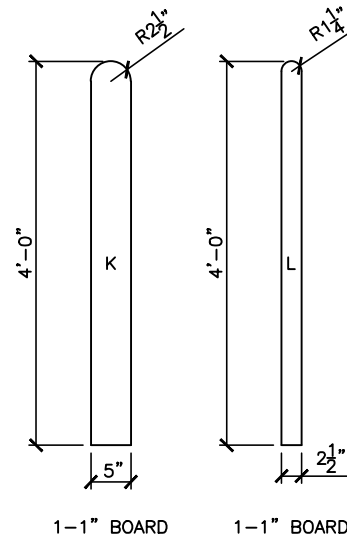

THIRD LAYER COMPONENTS

PROPERTY OF:

SNUG COTTAGE
HARDWARE LLC
MARYSVILLE MI.
48040

PRODUCT DESCRIPTION:

4' DOUBLE 'V' GATE COMPONENTS

ALL DIMENSIONS $\pm 0.125"$

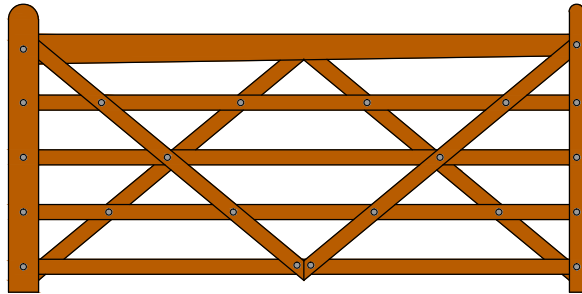

8' DOUBLE 'V' GATE

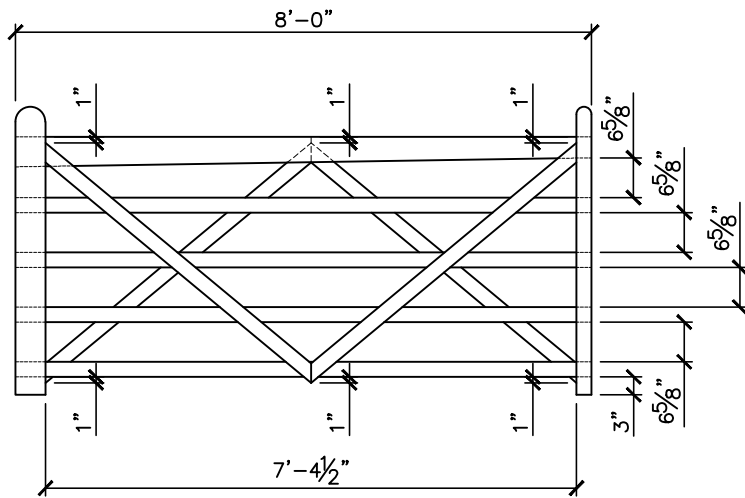

GATE DIMENSIONS

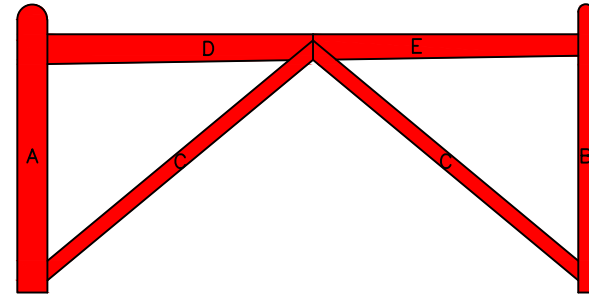

FIRST LAYER

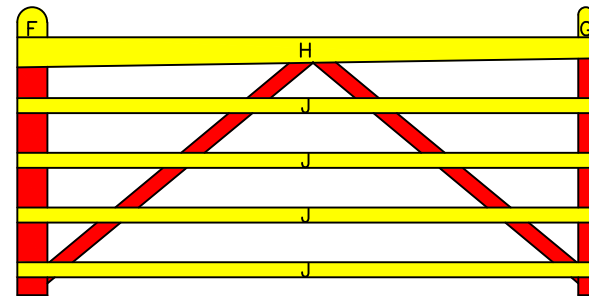

SECOND LAYER

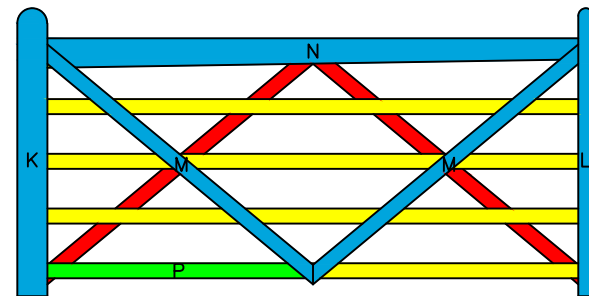

THIRD LAYER

BUILDING STEPS

PROPERTY OF:
 SNUG COTTAGE
 HARDWARE LLC
 MARYSVILLE MI.
 48040

PRODUCT DESCRIPTION:
 8' DOUBLE 'V' GATE
 ALL DIMENSIONS ±0.125"

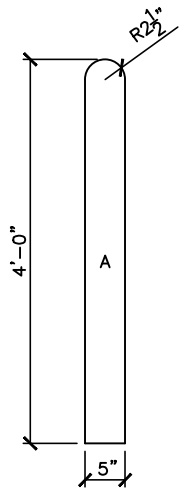

1-1" BOARD

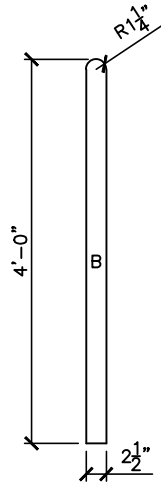

1-1" BOARD

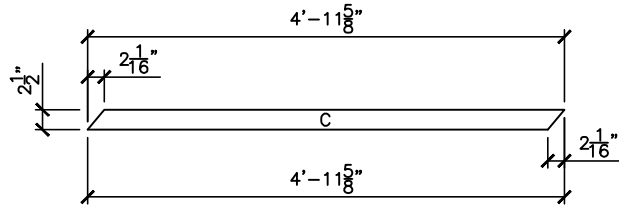

1-1" BOARD

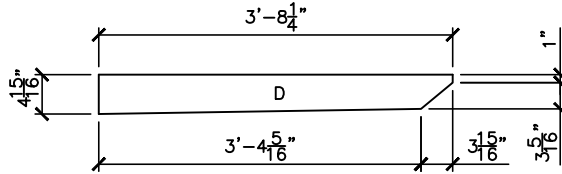

1-1" BOARD

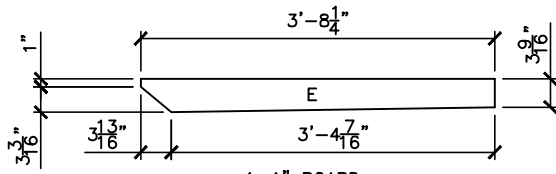

1-1" BOARD

FIRST LAYER COMPONENTS

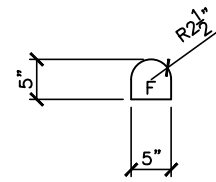

1-1" BOARD

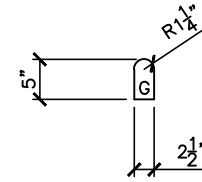

1-1" BOARD

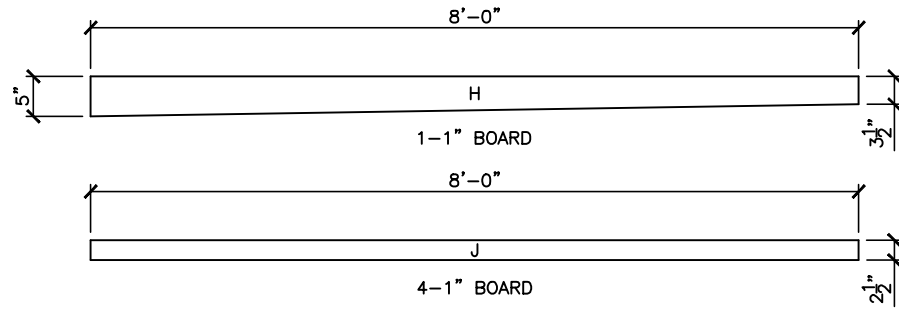

SECOND LAYER COMPONENTS

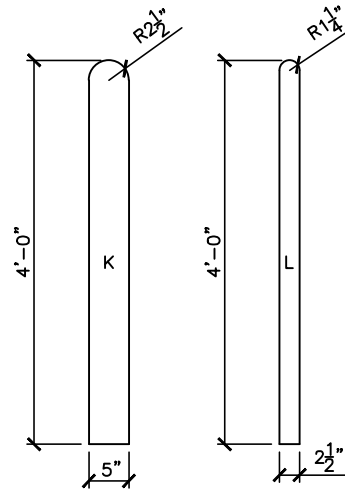

1-1" BOARD

1-1" BOARD

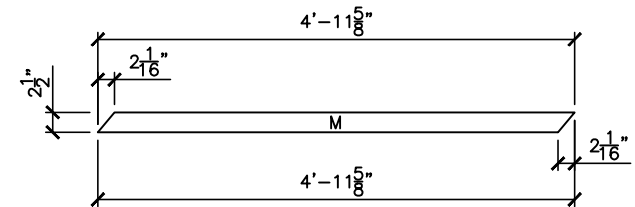

1-1" BOARD

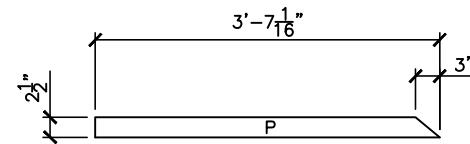

1-1" BOARD (OPTIONAL)

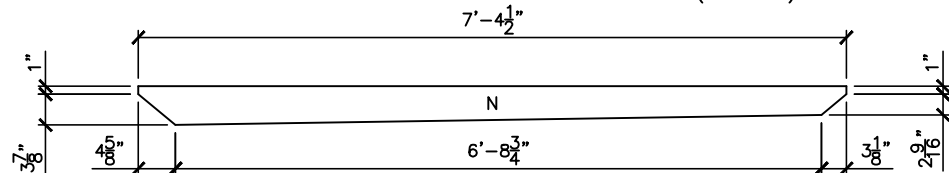

1-1" BOARD

THIRD LAYER COMPONENTS

PROPERTY OF:

SNUG COTTAGE
HARDWARE LLC
MARYSVILLE MI.
48040

PRODUCT DESCRIPTION:

8' DOUBLE 'V' GATE COMPONENTS

ALL DIMENSIONS ±0.125"